

Clamping nuts

Clamping nut DIN 6499

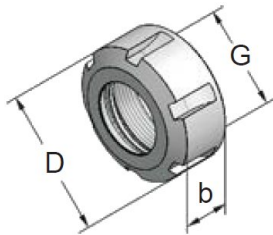

Art.-Nr.	Type	D	b	G	Nm max.
711120	UMQ / ER11	19	11	M14x0.75	30
716120	UMQ / ER16	28	17	M22x1.50	70
720120	UMQ / ER20	34	19	M25x1.50	100
725120	UMQ / ER25	42	20	M32x1.50	130
732120	UMQ / ER32	50	22	M40x1.50	170
740120	UMQ / ER40	63	25	M50x1.50	220
750120	UMQ / ER50	78	35	M64x2.00	300

Clamping nuts DIN 6499 friction bearing

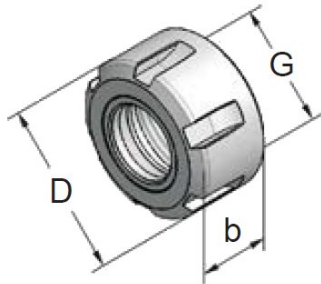
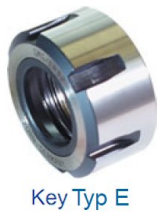

Art.-Nr.	Type	D	b	G	Nm max.
716123	GMG / ER16	28	18	M22x1.50	70
720123	GMG / ER20	34	20	M25x1.50	100
725123	GMG / ER25	42	20	M32x1.50	130
732123	GMG / ER32	50	23	M40x1.50	170
740123	GMG / ER40	63	26	M50x1.50	220

Key



Art.-Nr.	Type	for Clamping Nut	SW
911180	E 11 P	711120	17
916180	E 16 P	716120	25
920180	E 20 P		30
916181	E 16	716123, 716124, 716130	
920181	E 20	720120, 720123, 720124, 720130	
925180	E 25	725120, 725123, 725124, 725130	
932180	E 32	732120, 732123, 732124, 732130	
940180	E 40	740120, 740123, 740124, 740130	
950180	E 50	750120	

We reserve the right to make technical changes.

Clamping nuts

Clamping nuts DIN 6499 mini

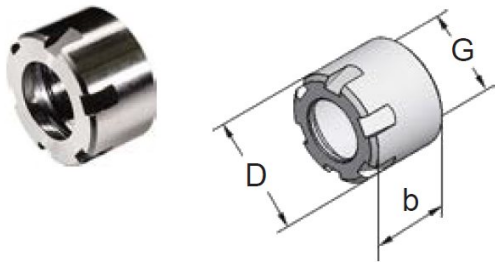

Key mini



Art.-Nr.	Type	D	b	G	Nm max.
908100	ER 8M	12	11	M10x0.75	6
911100	ER11M	16	11	M13x0.75	20
916100	ER16M	22	17	M19x1.00	30
920100	ER20M	28	19	M24x1.00	35
925100	ER25M	35	20	M30x1.00	40

Art.-Nr.	Type	for Clamping Nut
908160	E 8 mini	908100
911160	E 11 mini	911100
916160	E 16 mini	916100
920160	E 20 mini	920100
925160	E 25 mini	925100

Clamping nuts DIN 6499

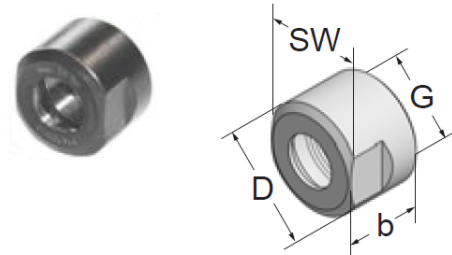

Art.-Nr.	Type	D	b	G	SW	Nm max.
716120-2	ER16	25	17.5	M20x1.00	22	30



916162	Wrench ER16	22
--------	-------------	----

Clamping nuts ETS

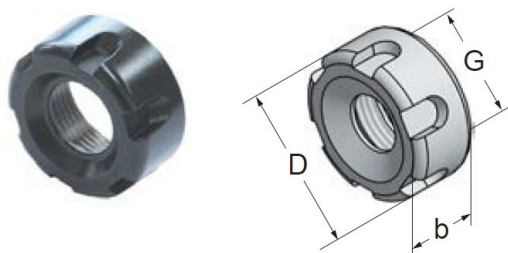
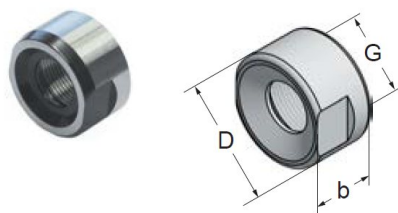

Art.-Nr.	Type	D	b	G	Key	Nm max.
709130	ETS 9	13.5	8	M10x0.75	762101	10
712130	ETS12	19	12	M14x0.75	912163	10
716120-2ETS	ETS16	27	15	M20x1.00	916163	30



Art.-Nr.	Type	for Clamping Nut
762101	Key ETS 9	709130
912163	Key ETS12	712130
916163	Key ETS16	716120-2ETS

Art.-Nr.	Type	D	b	G	Key	Nm max.
716130	ETS16	32	15	M22x1.50	916181	30
720130	ETS20	35	16.5	M25x1.50	920181	30
725130	ETS25	42	18.5	M32x1.50	925180	120
732130	ETS32	50	22	M40x1.50	932180	150
740130	ETS40	63	25	M50x1.50	940180	200

We reserve the right to make technical changes.

Clamping nuts

Clamping nuts DIN 6499 friction bearing for sealing discs

Delivery without sealing disc

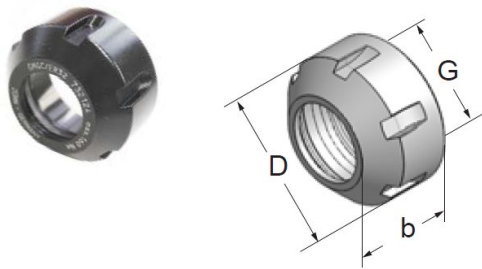

Art.-Nr.	Type	D	b	G	Nm max.	Sealing disc
716124	GMGC / ER16	28	23	M22x1.5	70	excl.DS / ER16
720124	GMGC / ER20	34	25	M25x1.5	100	excl.DS / ER20
725124	GMGC / ER25	42	26	M32x1.5	130	excl.DS / ER25
732124	GMGC / ER32	50	28	M40x1.5	170	excl.DS / ER32
740124	GMGC / ER40	63	31	M50x1.5	220	excl.DS / ER40

Clamping nuts DIN 6499 for sealing discs

Delivery without sealing disc

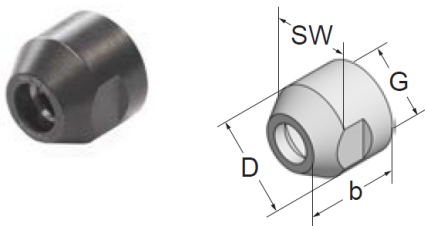

Art.-Nr.	Type	D	b	G	SW	Nm max.
716124-2	ER16C mini	25	22	M20x1.0	22	30
excl. Sealing disc DS / ER16						
916162	Wrench ER16				22	



Clamping nuts ETS mini for sealing discs

Delivery without sealing disc

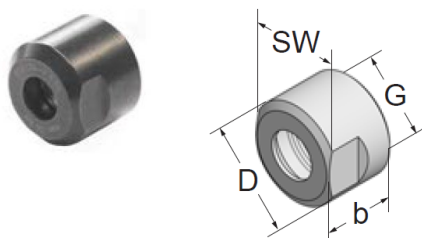

Art.-Nr.	Type	D	b	G	SW	Nm max.
716124-2ETS	ETS16C	27	22.5	M20x1.00	24	30
excl. Sealing disc DS / ER16						
916163	Wrench ETS16				24	



We reserve the right to make technical changes.

Clamping nuts

Clamping nuts DIN 6499 / DIN 6388 for balancing including 2 balancing weights Art.- Nr. 600101

Delivery without collet and tool

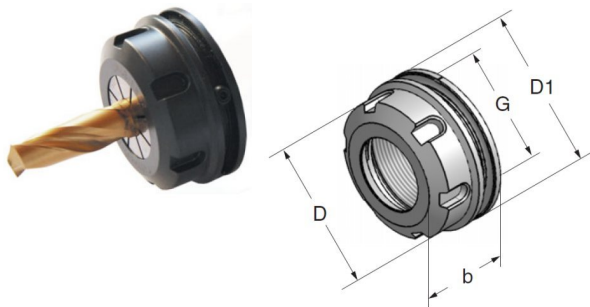

Key



Art.-Nr.	Type	D	D1	b	G	Key	Nm_max.
725120-B	ER25	42	46	24	M32x1.5	925180	130
732120-B	ER32	50	54	25	M40x1.5	932180	170
740120-B	ER40	63	64	27	M50x1.5	940180	220
825120-B	OZ25	63	63	30	M48x2.0	54668	200

Collet chucks in a balanced execution together with the clamped tools cannot absolutely guarantee the balance quality as desired for the cutting process in a high revolution speed range. The newly developed collet nut types allow the balancing as a complete unit after the clamping of the tool.

Art.-Nr.	Type	for clamping nuts
925180	E25	725120-B
932180	E32	732120-B
940180	E40	740120-B
54668	Hook Wrench	825120-B

We reserve the right to make technical changes.